



!"#\$ %&(')*+,-
./012 34567 899:56 9 55 ;<=>? 34567 899:56 9 5@
ABBC DDD E>?FGHI IFE IG J:E>H2 HGKFLE>?FGHI IFE IG
M+NO ABBC B PP IFE E>?FGHI
QNO ABBC D1HRF IFE E>?FGHI





STUVWX

! " # \$ %

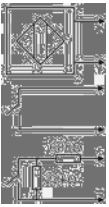

*+YZ[\]^_`

&'# ()* + , - . ++ - .

abcd	abe fg	fg	g	hij	klmn opq	rs	tu
	Xvwx z{)~ X• E €•,0fe	...†† .%Š €•,0f	=: :CE(•: :CE =: :CE(•: :CE =: :CE(•: :CE	Ž ~ X• Ž ~ Ž ~	E €•,0fe }Ž• (• •	CE(• 6 6	9
	X• E €•,0fe }Ž•xy "um	•-†. -~%Š €•,0f	=: :CE(•: :CE =: :CE(•: :CE =: :CE(•: :CE	Ž ~ ~•) Ž ~ Ž ~	X• E €•,0fe	CE(• 5 5	8
	™š;œ•ž ™s)~)œ e	...†† œŸ% Š	=: :CE(•: :CE =: :CE(•: :CE =: :CE(•: :CE	Ž ~ i, ø) Ž ~ Ž ~	£se } }Ž• (• }Ž• (•	CE(• @: @: }~¤ @: ¥ CE(•	@: @: @: @: @:
	LX9E }Ž•.† •S	•-†† œŸ% Š	=: :CE(•: :CE =: :CE(•: :CE	Ž ~ ~•) Ž ~	X .@e	CE(•	

/*0123

45678

ª = : < :CE(•: :CE
= = k«-Y)-†@
< †.ˆ %Š-ˆ°•,0
CE(• ±y²³´µ%¶
Ž ~
Ž ~
Ž ~
CE . , -€¹º,»œ¼½f

9:;<

¼¿ÀÁ 5 E E 8 5EE
ÂÃÄÅ 9 Ä
ÆÁÇÈ 9É=CE Ê
ËĜĤ 9É=CEL 9Ê
ÏÆĪ- : •6 Ê
Ī-Đ • Ä

/*01=>

.ĐÑÒ .ĐÓ™ÑÒ

.†°Ö ÖÖ †JÁ 6 6: x†JÁ 6 6: : x
ØÙ 0 5 65
Ú. ÛÜÝ.-5P ß ™£Ÿ. XP
àáâ .Đv: †P ße v : †P
Qã . • v.6(†)-3.3(5 TD -.03.020 [(ââ)-11.8(â)-11-7.6(†)-ää -1.76(°)]5828 :)6.5 TD7201 æD .0086 Tc [(CE)9.

5 6

78 +9;< =>?@% A0>B' C

DEF%G = HI@%'

0 9

0	+,J KL	56	MN-O 4
	*PL	Q)
	*PL)	3 Q)
	*PL	Q)
	*PL)	3 Q)
	*PL	Q)
	*PL)	3 Q)
	*PL	Q)
	*PL)	3 Q)
	*PL	Q)
	*PL)	3 Q)
	*PL	Q)
	*PL)	3 Q)

&

R *

5 6

S TU V W.X%D

0

0	MN-	4

J J LMNfgh !"

U -R T+

„...ífbùø™š›œ•ž™se ı ı%oo Tı)ııı.Łse • ÁCE •Áæ hi
 }Ž }~ »Ó»Zwı }Žv) „... ±yæ %¶ıñ ıı
 .Đx)Žx)~ ı%oo ı Ž -x Ž -x Ž -æ
 %¶ıı (JÁ6 9 5 ı o CEı• •CEı• ø²³cdklı²³ }~ ıæ
)*
 ,™š›œ•ž™se æ

4

g	}Ž	}Ž	}~	}~
= : < :CEı• :CE	™š›œ	p	ııı.Łs	p
= : < :CEı• :CE	™š›œ	p	ııı.Łs	ııı.Łs
= : < :CEı• :CE	™š›œ	™š›œ	ııı.Łs	ııı.Łs

0123

ÁÁ. }Ž:ııı.Đı €9 Áf

ıœ

ııı.Đ Áıı hi
 }Že ímı™š›œ•ž™s
 }Žı) ı5 É
 }Ž }~ııı.ŁE É
 }Ž }~ııı.ŁE »Zw f
 }~ııı.ŁE •}Ž p d ııı.ŁE
 }~ııı.ŁE •}Ž p d ııı.ŁE
 }Žv)ııı.ŁE = f
 }~ııı.ŁE 6 9E d }Žv))
 }~ııı.ŁE E d }Žv)ııı.ŁE
 }~ııı.ŁE 23mııı.ŁE ııı.ŁE
 Łsııı.ŁE 3 Ó7 9 Á3 9 7 • Á3 9 7
 ııı.ŁE
 á •
 ç •J ııı.ŁE
 ç •J ııı.ŁE ııı.ŁE B
 ııı.ŁE }Ž:ııı.ŁE }~ııı.ŁE 89
 ÁÁÁÁ }Ž:ııı.ŁE 9 Áııı.ŁE EHGf
 }Ž:ııı.ŁE 9 Áııı.ŁE EHGf
 }~ııı.ŁE 9 Áııı.ŁE EHGf

	3hi 7	3hi 7
	3hi 7	X3hi 7
ııı.ŁE	}Ž }~ııı.ŁE » }v)	ııı.ŁE
ııı.ŁE =	}Ž }~ııı.ŁE » }v)	ııı.ŁE

ıœ)Žııı.ŁE f ııı.ŁE x X ııı.ŁE = ııı.ŁE

J K cBNfgh !"

. { T e

™ ÁCE •Á ø'æe - ~%oT- ïibùø ²,!'•\$~|~)± LX9E æ
 %¶'ñ .-.Ðx)Žx)- ~%oæ%¶])- ~)) ,)...±yæ ° Ž -æ
 %¶ (JÁ6 9 5 - o CE• ø²³cdkl-²³ }- .æ

)*

²,!'- ²\$~|

4

g	}Ž	}Ž	}~	}~
=:~:CE•: :CE \$.©	p	}~ LX9E	p

0123 ìe }-€²³mf ç £s)-
 ,)æ. Á Á
 Ī-Ð Á-± 9 ,.- E 9 E
 }Že ²³m-\$.©e u)æ • 8 5 t@m-•= ›h
 }Ž. 6• d - .Û~%o }-:Ð-}Ž:}-~ 89
 }Ž. •9 d ~== .ÁÁÁÁ }Ž:}-~ 9 Á€EHGf
 }Ž)-. 9E LX Á }-:Ð- 9 Á€EHGf
 }Ž L)-v) }Ž:Ð- 9 Á€EHGf
 v),...3•= 7 }-v))- 9 ÁÁ. }Ž:}-:Ð- €9 Áf
 }-v)~)~ p WX23
 }-e ĩm- LX9E òè J?H> Ø> Á
). 9 Á 'µ j €†@ 8:5f
 },- 6 E E 9 F 5 ‹F E
 n 9E F 88 E ÁF 9 G= •F E•
 á • ?@Y Z [\ -]J^_`
 ç•J -Ð }-~ ~ ß -)Žv)

)*abY



J K cBNfgh !"

. { T e

™ ÁCE •Á ø'æe - ~%oT- ïibùø ²,!'•\$~|~)± LX9E æ
 %¶'ñ .-.Ðx)Žx)- ~%oæ%¶])- ~)) ,)...±yæ ° Ž -æ
 %¶ (JÁ6 9 5 - o CE• ø²³cdkl-²³ }- .æ

)*

²,!'- ²\$~|

4

g	}Ž	}Ž	}~	}~
=:~:CE•: :CE \$.©	\$.©	}~ LX9E	}~ LX9E

0123 ç•J }-~ ~ ß
 -)Žv)
 Ī-Ð Á-± 9 hi u)æ • : †@m-•= ›h
 }Že ²³m-\$.©e .Û~%o }-:Ð-}Ž:}-~ 89
 }Ž. 6• d - .ÁÁÁÁ }Ž:}-~ 9 Á€EHGf
 }Ž. •9 d ~== }-:Ð- 9 Á€EHGf
 }Ž)-. 9E LX Á }Ž:Ð- 9 Á€EHGf
 }Ž L)-v) ÁÁ. }Ž:}-:Ð- €9 Áf
 v),...3•= 7 }-v))- 9 WX23
 }-v)~)~ p òè J?H> Ø> Á
 }-e ĩm-}± - LX9E 'µ j €†@ : x X: 9f
). 9 Á E 9 F 5 ‹F E
 },- 6 E F 88 E ÁF 9 G= •F E•
 n 9E ?@Y Z [\ -]J^_`
 á •
 ç•J -Ð }-~ ~ ß -)Žv)
)*abY

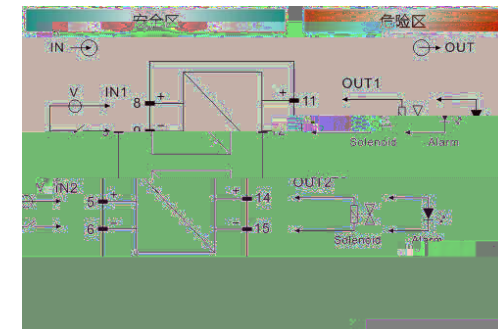
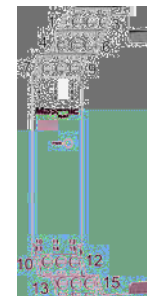

?@Q S}}

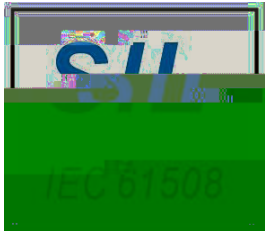

?@
 CE·€CE>KB <GB1 HB·1 12f'μ <JÁ6 9 5->JÁ6 9 -
 <JÁ 5X@: è - 23 ø23 Ô €CE·f x
 μ 'æ±y23'μ ñ 23) - ø
 - ½ Ô x ½ xið xJ Á.:f·Ô...
 ° æ

u ~·
 <JÁ 6 9 : ýñ ò o 23cdkl€CE·fýø n
 <JÁ6 9 5 øñò- ñòø23 Ô €CE·f ø'μæ
 è <JÁ6 9 99: 9 ýø o μ HF 1 øñ

òæ23Š ±y23klø¥ æCE·CE ø23 Ô CE·CE klø ø CE·
 "ø CE·) CE·; |4 CE·«23»æø¥ 4CE· 4CE·

€ ·,

23±y ø±yæ23±yø-o íí ½ ø í · TM
 ø Á- Ñμ Z 23 æCE· CE·CE "ø ù - ùñòø23
 ±yøý ød æCE· %ø ø - \$-CE·CE óy ùñòø23±yø æCE·
 'μ X -CE··CE·X- ý-CE·X \$æ
 d 23 Ô - - ‡ J J J 23»æklø23±y è Ý

CE·	€ ñò	ñò- - ±yñòø@	= > f	\$ñò- - -	íí	=*f
X		:9 = > :X		:@ =• :5		
		:X = > :		:5 =• :8		
		: = > :		:8 =• :6		
		: = > :		:6 =• :9		

?@f,...t&'u†'f,,

x ±y23 ÷kø Ñ J J J 23»ækly · Ñ ùñòø±y2
 3- ù ø · 3 ø · ø ñÖÖ ØÙ 0 X 5
 <JÁ 6 9 5 ù "øñòæ
 xCE· ø " - Ñ ½ y23noß = J - klø
 ø Ò- "CE· æ -klø@ ß=0 Ž... - μ = J
 x Öy ið nOø ØÙ 5 6 6 9 5 øñò- %¶ øg- ß±
 y23%¶ ÖÖ ±y23»æø.í"è <JÁ6 6: : øñò- „ ... ø Á
 ñ\$ hç ò.ø%¶ J Á Öyøñòæ

P%Š(WXCE·}}

x Īx xw x Ü %
 ý- ø -a]ððÖ øíí b ù-
 bù øø.Ü]æððÖí
 ð øø è æ
 XŽ•'uo'to,€o"

XŽ•'uo'to,€o"

23 ðklø ø%¶ø'gý-
 1ñ ððÖíðý øÜ÷ x
 ¼- n ððÖÜ÷-aðá Á
 ððÖÜ÷ífbù #
 # s n m

d Ô	÷k ý <JÁ ØÙ 5 6 <JÁ6 8@: J 9 X	s rÔ
	Á	
Ü	Á	
	Ù	
	3 7	
.Ô	Á	
è . Ô	Ü	
Ô		

"P%Š(u-™Š"p

ðè ØÙ 5 6 ø]æ "-
 .Ü øÆÁ \$d ÆÁø
 øÜ÷ ÆÁøæk

ÆÁ	\$d ÆÁ	.Ü23Öy
0	X9 Ê	↓ \$
0	Ê	
0	Ê	
0X	9Ê	
09	Ê	
06	59Ê	

• "£g|}

²g²³Šno ² ðklø ý¬
² ²³bù ™ Ýíí#øe } ~ ²
³e •²³#•íí#æ.)ýh ^— ^

"WX¹⁰» ¼

x²³Šn²

²³bú⁻²

" ó]Ă ø

xá -

Ye †x.Đ†

Ů